

Uninterruptible Power Systems

10~20KVA

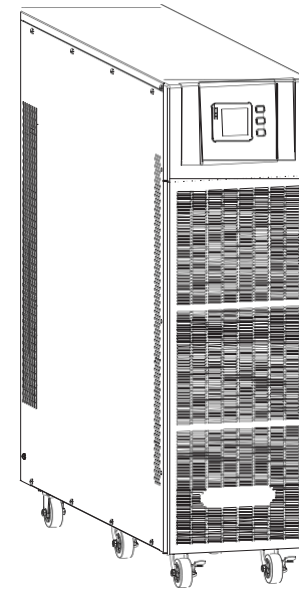

Operation Manual

4256-0912 C

All rights reserved.

The information in this document is subject to change without notice.

Publish statement

Thank you for purchasing this series UPS.

This series UPS is an intelligent, three phase in Three phase out, high frequency online UPS designed by our R&D team who is with years of designing experiences on UPS.

With excellent electrical performance, perfect intelligent monitoring and network functions, smart appearance, complying with EMC and safety standards, The UPS meets the world's advanced level.

Read this manual carefully before installation

This manual provides technical support to the operator of the equipment.

Contents

1 · Safety	2
1.1 Safety notes	2
1.2 Symbols used in this guide	2
2 · Main Features	3
2.1 Summarization	3
2.2 Functions and Features	3
3 · Installation	4
3.1 Unpack checking	4
3.2 Cabinet Outlook	4
3.3 LCD control panel	5
3.4 Installation notes	6
3.5 External Protective Devices	7
3.6 Power Cables	7
3.7 Power cable connect	8
3.8 Battery connection	9
3.9 UPS Multi—Module Installation	10
3.10 Computer access	11
4 · Operation	13
4.1 Operation Modes	13
4.2 Turn on/off UPS	14
4.3 The LCD Display	19
4.4 Parameters setting	24
4.5 Display Messages/Troubleshooting	29
4.6 Options	31
Appendix 1 Specifications	33
Appendix 2 Problems and Solution	34
Appendix 3 USB communication port definition	36
Appendix 4 RS232 communication port definition	37
Appendix 5 RS485 communication port definition	38
Appendix 6 BAT_T communication port definition	39
Appendix 7 Dry contact port communication port definition	40
Appendix 8 REPO instruction	41

1 · Safety

Important safety instructions – Save these instructions

There exists dangerous voltage and high temperature inside the UPS. During the installation, operation and maintenance, please abide the local safety instructions and relative laws, otherwise it will result in personnel injury or equipment damage. Safety instructions in this manual act as a supplementary for the local safety instructions. Our company will not assume the liability that caused by disobeying safety instructions.

1.1 Safety notes

1. Even no connection with utility power, 220/230/240VAC voltage may still exist at UPS outlet !
2. For the sake of human being safety, please well earth the UPS before starting it.
- 3 · Don't open or damage battery, for the liquid spilled from the battery is strongly poisonous and do harmful to body !
- 4 · Please avoid short circuit between anode and cathode of battery, otherwise, it will cause spark or fire !
- 5 · Don't disassemble the UPS cover, or there may be an electric shock !
- 6 · Check if there exists high voltage before touching the battery
- 7 · Working environment and storage way will affect the lifetime and reliability of the UPS. Avoid the UPS from working under following environment for long time
 - ◆ Area where the humidity and temperature is out of the specified range(temperature 0 to 40°C , relative humidity 5%-95%)
 - ◆ Direct sunlight or location nearby heat
 - ◆ Vibration Area with possibility to get the UPS crashed.
 - ◆ Area with erosive gas, flammable gas, excessive dust, etc
- 8 · Keep ventilations in good conditions otherwise the components inside the UPS will be over-heated which may affect the life of the UPS.

1.2 Symbols used in this guide



WARNING!

Risk of electric shock



CAUTION!

Read this information to avoid equipment damage

2 · Main Features

2.1 Summarization

This series UPS is a kind of three-in-three-out high frequency online UPS, it provides three specifications: The 10kVA/15kVA and 20kVA. The products are modularized and adopt the N+X redundancy. It can flexibly increase the number of the UPS modules according to the load capacity which is convenient for flexible allocation and gradually investment.

The UPS can solve most of the power supply problems, such as blackout, over-voltage, under-voltage, voltage sudden drop, oscillating of decreasing extent, high voltage pulse, voltage fluctuation, surge, inrush current, harmonic distortion (THD), noise interference, frequency fluctuation, etc..

This UPS can be applied to different applications from computer device, automatic equipment, communication system to industry equipment.

2.2 Functions and Features

◆3Phase In/3Phase Out UPS

It is 3Phase In/3Phase Out high-density UPS system, of which input current is kept in balance. No unbalance problem might occur.

◆Digital Control

This series UPS is controlled by Digital Signal Processor (DSP); enhance, it increases reliability, performance, self-protection, self-diagnostics and so on.

◆Battery Configurable from 16 blocks to 20 blocks

The battery voltage of this series UPS can be configured at 16 blocks, 18 blocks or 20 blocks according to your convenience.

◆Charging Current is configurable

Via setting tool, the user may set the capacity of the batteries as well as reasonable charging current as well as maximum charging current. Constant voltage mode, constant current mode or floating mode can be switched automatically and smoothly.

◆Intelligent Charging Method

The series UPS adopts advanced three-stage charging method—

1st stage: high current constant current charging

to guarantee to charge back to 90%;

2nd-stage: Constant Voltage

In order to vitalize battery and make sure batteries are fully charged

3rd stage: floating mode.

With this 3-stage charging method, it extends the life of the batteries and guarantees fast charging.

◆LCD Display

With LCD plus LED displays, the user may easily get UPS status and its operational parameters, such as input/output voltage, frequency & load%, battery % and ambient temperature, etc..

◆Intelligent Monitoring Function

Via optional SNMP Card, you may remotely control and monitor the UPS.

◆EPO Function

The series UPS may be completely shut off when the EPO is pressed. REPO function (Remote EPO) is also available in this series UPS.

3 · Installation

3.1 Unpack checking

1. Don't lean the UPS when moving it out from the packaging
2. Check the appearance to see if the UPS is damaged or not during the transportation, do not switch on the UPS if any damage found. Please contact the dealer right away.
3. Check the accessories according to the packing list and contact the dealer in case of missing parts.

3.2 Cabinet Outlook

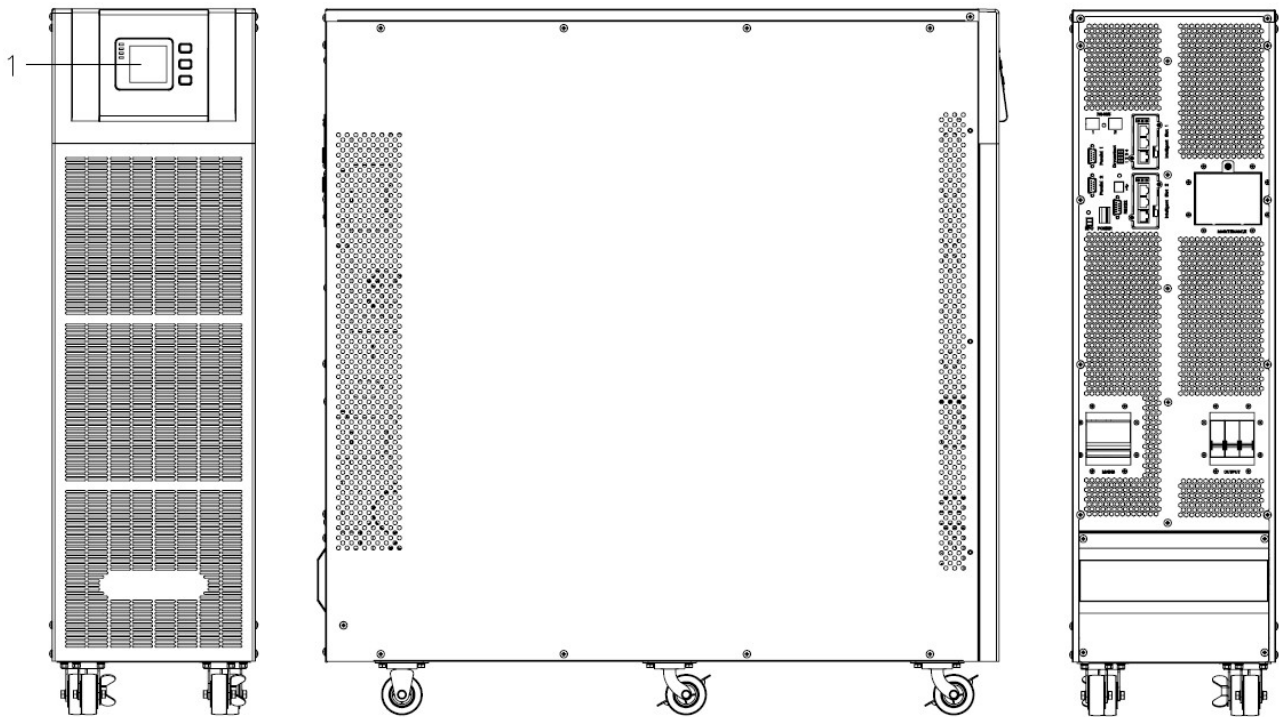

Front View

Side View

Rear View

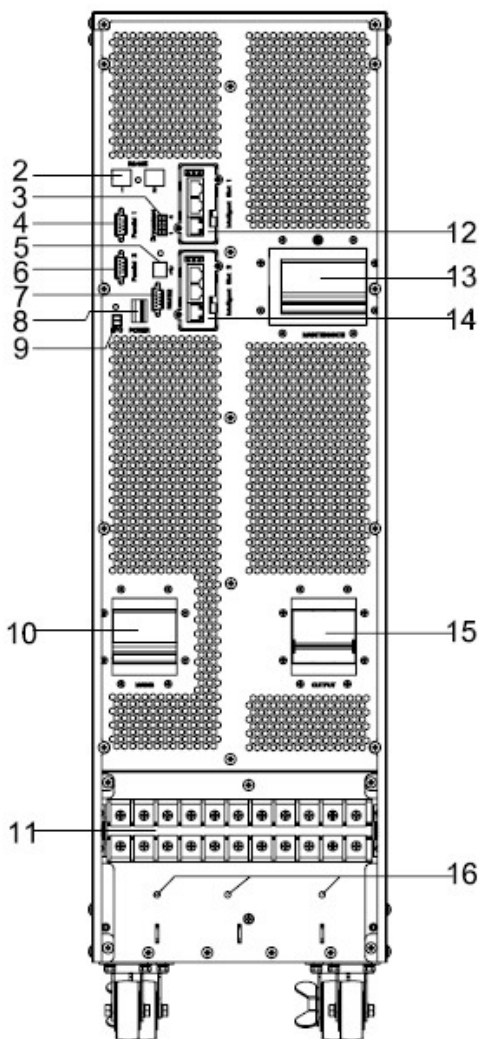

Rear View (terminal block without cover)

(1) LCD panel	(2) RS485 port	(3) Dry contact port	(4) Parallel port 1
(5) USB port	(6) Parallel port 2	(7) RS232	(8) Power Switch
(9) REPO port	(10) I/P Switch	(11) Terminal block for Input, output & battery	(12) Intelligent Slot 1 (SNMP card/ Relay card)
(13) Maintenance switch & its cover	(14) Intelligent Slot 2 (SNMP card/ Relay card)	(15) O/P Switch	(16) GND

3.3 LCD control panel

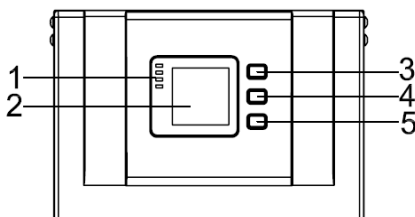

LCD control panel introduction

(1) LED (from top to bottom: "alarm", "bypass", "battery", "inverter") (2) LCD display (3) scroll button (4) Off button (5) On button (battery cold start switch)

3.4 Installation notes

Note: Consider for the convenience of operation and maintenance, the space in front and back of the cabinet should be left at least 100cm and 80cm respectively when installing the cabinet.

◆ Please place the UPS in a clean, stable environment, avoid the vibration, dust, humidity, flammable gas and liquid, corrosive. To avoid from high room temperature, a system of room extractor fans is recommended to be installed. Optional air filters are available if the UPS operates in a dusty environment.

◆ The environment temperature around UPS should keep in a range of 0°C ~ 40°C. If the environment temperature exceeds 40°C, the rated load capacity should be reduced by 12% per 5°C. The max temperature can't be higher than 50°C.

◆ If the UPS is dismantled under low temperature, it might be in a condensing condition. The UPS can't be installed unless the internal and external of the equipment is fully dry. Otherwise, there will be in danger of electric shock.

◆ Batteries should be mounted in an environment where the temperature is within the required specs. Temperature is a major factor in determining battery life and capacity. In a normal installation, the battery temperature is maintained between 15°C and 25°C. Keep batteries away from heat sources or main air ventilation area, etc.



WARNING!

Typical battery performance data are quoted for an operating temperature between 20°C and 25°C. Operating it above this range will reduce the battery life while operation below this range will reduce the battery capacity.

◆ Should the equipment not be installed immediately it must be stored in a room so as to protect it against excessive humidity and or heat sources °



CAUTION!

An unused battery must be recharged every 6 months Temporarily connecting the UPS to a suitable AC supply mains and activating it for the time required for recharging the batteries.

◆ The highest altitude that UPS may work normally with full load is 1500 meters. The load capacity should be reduced when this UPS is installed in place whose altitude is higher than 1500 meters, shown as the following table:

(Load coefficient equals max load in high altitude place divided by nominal power of the UPS)

Altitude (m)	1500	2000	2500	3000	3500	4000	4500	5000
Load coefficient	100%	95%	90%	85%	80%	75%	70%	65%

◆ The UPS cooling is depending on fan, so it should be kept in good air ventilation area. There are many ventilation holes on the front and rear, so they should not be blocked by any exotic obstacles.

3.5 External Protective Devices

For safety reasons, it is necessary to install, external circuit breaker at the input A.C. supply and the battery. This chapter provides guidelines for qualified installers that must have the knowledge of local wiring practices for the equipment to be installed.

◆**External Battery**

The UPS and its associated batteries are protected against the effect of over-current through a DC compatible thermo-magnetic circuit-breaker (or a set of fuses) located close to the battery.

◆**UPS Output**

Any external distribution board used for load distribution shall be fitted with protective devices that may avoid the risk of UPS overloaded.

◆**Over-current**

Protection device shall be installed at the distribution panel of the incoming main supply. It may identify the power cables current capacity as well as the overload capacity of the system .



CAUTION!

Select a thermo magnetic circuit-breaker with an IEC 60947-2 trip curve C (normal) for 125% of the current as listed below.

3.6 Power Cables

◆The cable design shall comply with the voltages and currents provided in this section, Kindly follow local wiring practices and take into consideration the environmental conditions (temperature and physical support media) .



WARNING !

Upon starting. Please ensure that you are aware of the location and operation of the external isolators which are connected to the UPS input/bypass supply of the mains distribution panel. Check to see if these supplies are electrically isolated. And post and necessary warning signs to prevent any inadvertent operation.

◆For future expansion purpose, it is economical to install power cable according to the full rating capacity initially. The diameter of cable is shown bellow :

UPS cabinet	Cable Dimension			
	AC Input (mm ²)	AC Output (mm ²)	DC Input (mm ²)	Grounding (mm ²)
10KVA	4	4	10	4
15KVA	6	6	16	6
20KVA	8	8	20	8



CAUTION!

Protective earth cable: Connect each cabinet to the main ground system. For Grounding connection, follow the shortest route possible .



WARNING!

Failure to follow adequate earthing procedures may result in electromagnetic interference or in hazards involving electric shock and fire

3.7 Power cable connect

Once the equipment has been finally positioned and secured, connect the power cables as described in the following procedure.

Verify the UPS is totally isolated from its external power source and also all power isolators of the UPS are open. Check to see if they are electrically isolated, and post any necessary warning signs to prevent their inadvertent operation.

Remove the cover of terminals for wiring easily.

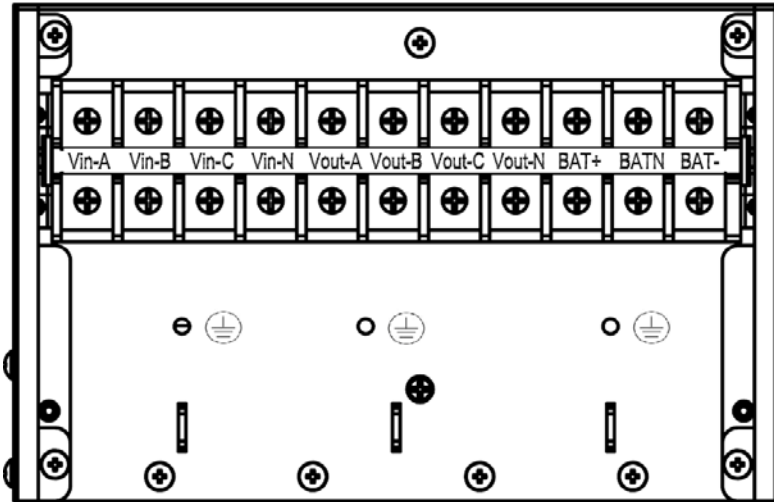

Terminal sequence from left to right: Input phase A(L1), input phase B(L2), input phase C(L3), input Neutral line, output phase A(L1), output phase B(L2), output phase C(L3), output Neutral line, battery positive, battery Neutral, battery negative. There are 3 connectors of GROUND under the terminal block.

Choose appropriate power cable. (Refer to the table above) and pay attention to the diameter of the connection terminal of the cable that should be greater than or equal to that of the connection poles;

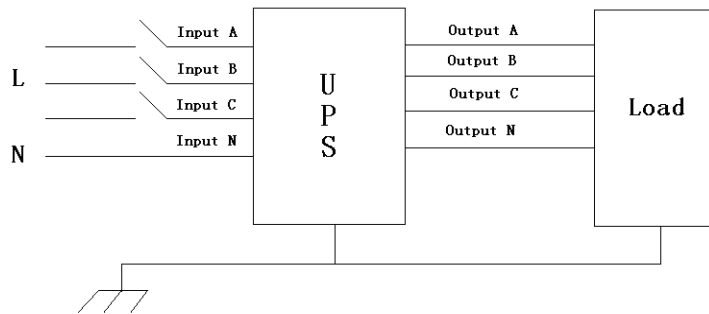

WARNING!



If the load equipment is not ready to accept power on the arrival of the commissioning engineer then ensure that the system output cables are safely isolated at their ends

Connect the safety earth and any necessary bonding earth cables to the copper earth screw located on the floor of the equipment below the power connections. All cabinets in the UPS must be grounded properly.



CAUTION!

The earthing and neutral bonding arrangement must be in accordance with local and national codes of practice.

3.8 Battery connection

The UPS adopts positive and negative double battery framework, totally 16pcs (optional 18/20) in series. A neutral cable is retrieved from the joint between the cathode of the 8th (9th/10th) and the anode of the 9th (10th/11th) of the batteries. Then the neutral cable, the battery Positive and the battery negative are connected with the UPS respectively. The battery sets between the Battery anode and the neutral are called positive batteries and that between neutral and cathode are called negative ones. The user can choose the capacity and the numbers of the batteries according to their desire.

External battery connections for long-run units.

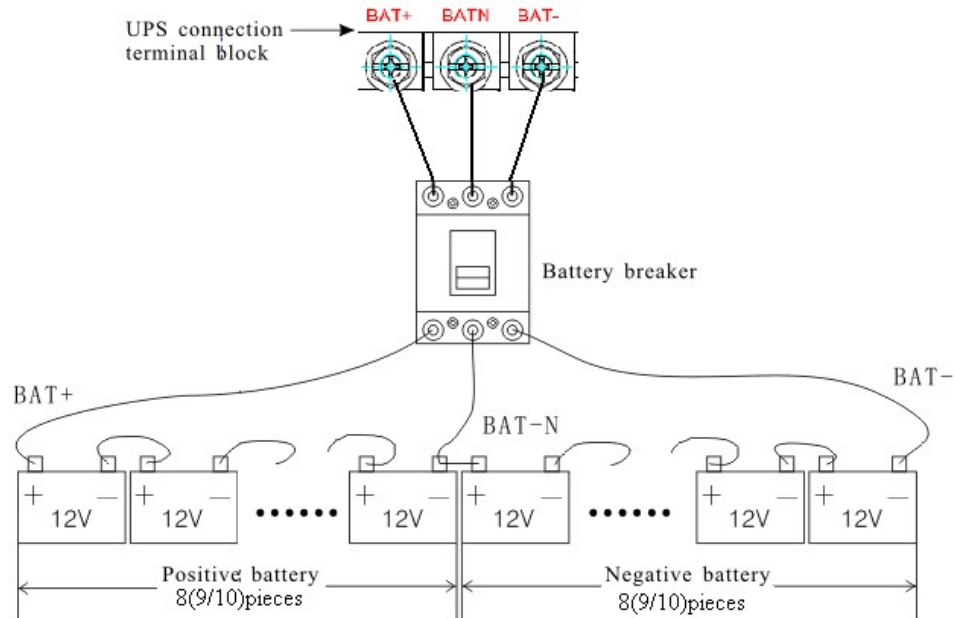

Note :

The BAT+ of the UPS connect poles is connected to the anode of the positive battery, the BAT-N is connected to the cathode of the positive battery and the anode of the negative battery, the BAT- is connected to the cathode of the negative battery . Factory setting of the long-run unit is battery quantity---16pcs, battery capacity---12V65AH(charger current 9.75A). When connecting 18/20 batteries, please re-set desired battery quantity and its capacity after UPS starts at AC mode. Charger current can be adjusted automatically according to battery capacity selected. All related settings can be done through LCD panel or monitoring software



CAUTION!

Ensure correct polarity battery string series connection. i.e. inter-tier and inter block connections are from (+) to (-) terminals. Don't mix batteries with different capacity or different brands, or even mix up new and old batteries, either.



WARNING!

Ensure correct polarity of string end connections to the Battery Circuit Breaker and from the Battery Circuit Breaker to the UPS terminals i.e. (+) to (+) / (-) to (-) but disconnect one or more battery cell links in each tier. Do not reconnect these links and do not close the battery circuit breaker unless authorized by the commissioning engineer.

3.9 UPS Multi— Module Installation

The basic installation procedure of a parallel system comprising of two or more UPS modules is the same as that of single module system. The following sections introduce the installation procedures specified to the parallel system.

3.9.1 Cabinet installation

Connect all the UPS needed to be put into parallel system as below picture.

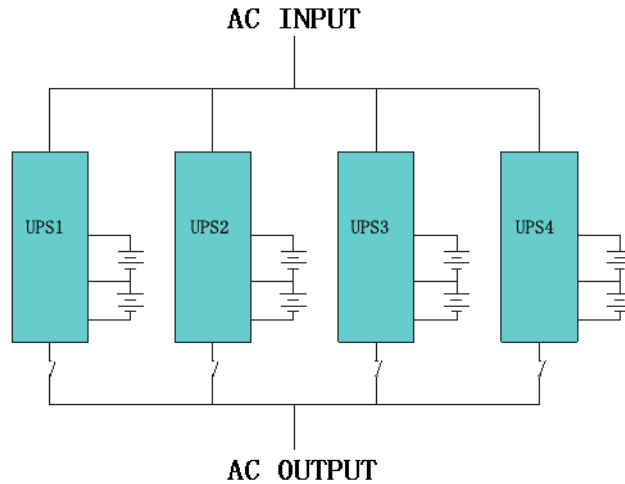

Make sure each UPS input breaker is in “off” position and there is no any output from each UPS connected. Battery groups can be connected separately or in parallel, which means the system itself provides both separate battery and common battery.



WARNING!

Make sure the N、A (L1)、B (L2)、C (L3) lines are correct, and grounding is well connected.

3.9.2 Parallel cable installation

Shielded and double insulated control cables available must be interconnected in a ring configuration between UPS units as shown below. The parallel control board is mounted on each UPS module units. The ring configuration ensures high reliability of the control.

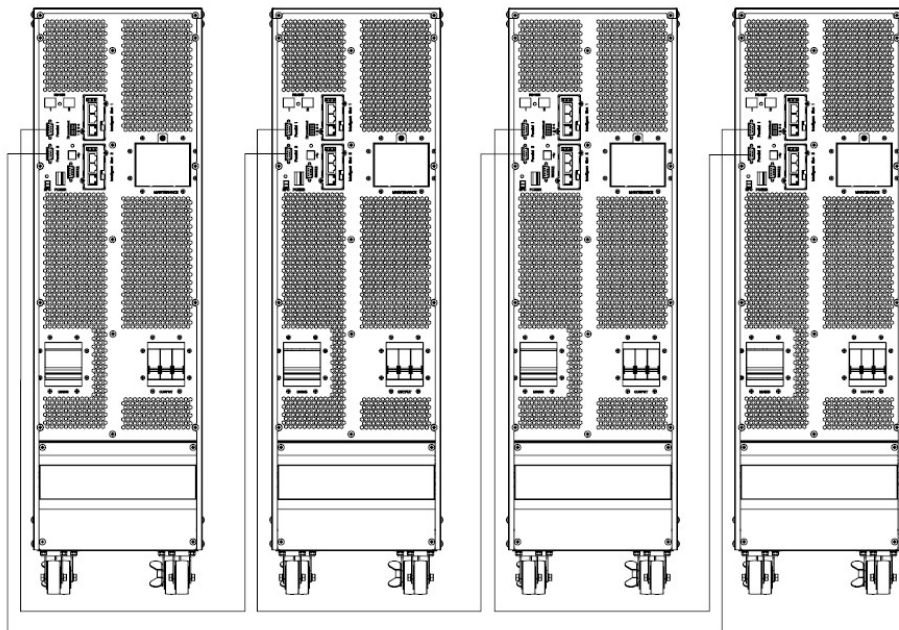

3.9.3 Requirement for the parallel system

A group of paralleled modules behave as one large UPS system but with the advantage of presenting higher reliability. In order to assure that all modules are equally utilized and comply with relevant wiring rules, please follow the requirements below:

- 1) All UPS modules must be of the same rating and be connected to the same bypass source.
- 2) The outputs of all the UPS modules must be connected to a common output bus.
- 3) The length and specification of power cables including the bypass input cables and the UPS output cables should be the same. This facilitates load sharing when operating in bypass mode.

3.10 Computer access

◆ One end of a USB cable connect to the computer, the other end connect to the USB port on the UPS.

◆ Open the software Muser4000, click “system” button.

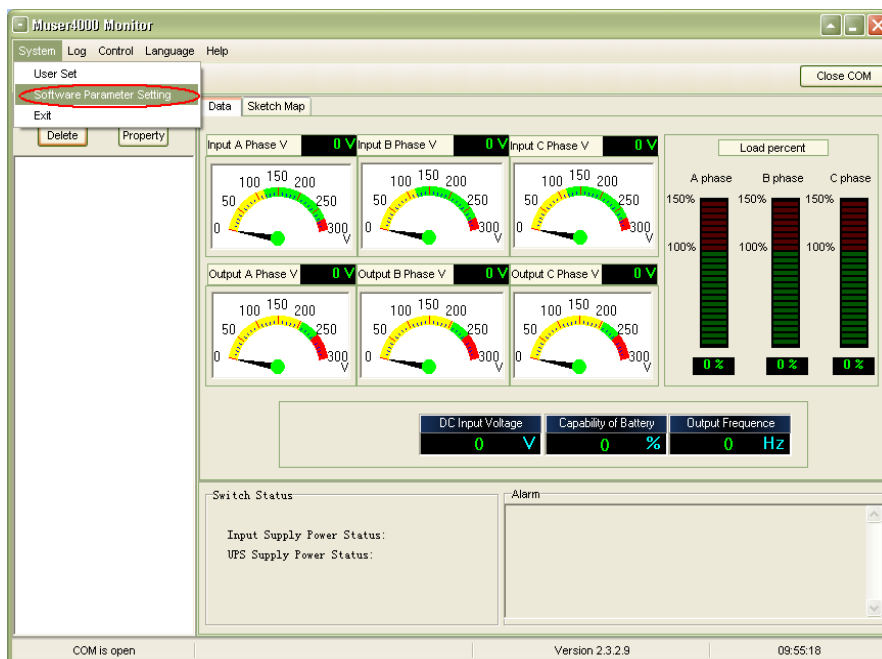

◆ A window of “Software Parameter Setting” comes out as below, COM choose according to the UPS , baud rate choose 9600, protocol choose “HIP”, then save this setting.

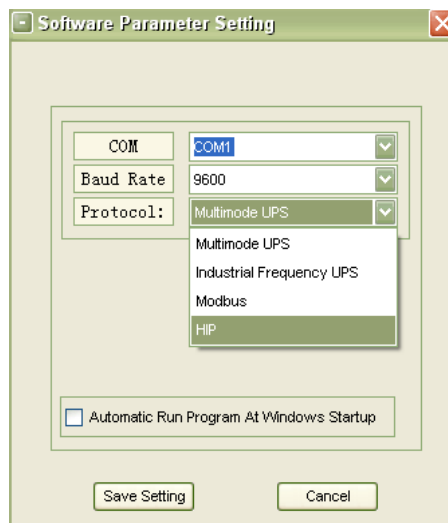

◆On the main page of Muser4000, click the button of “Append”, then goes to a window of “Append equipment”.

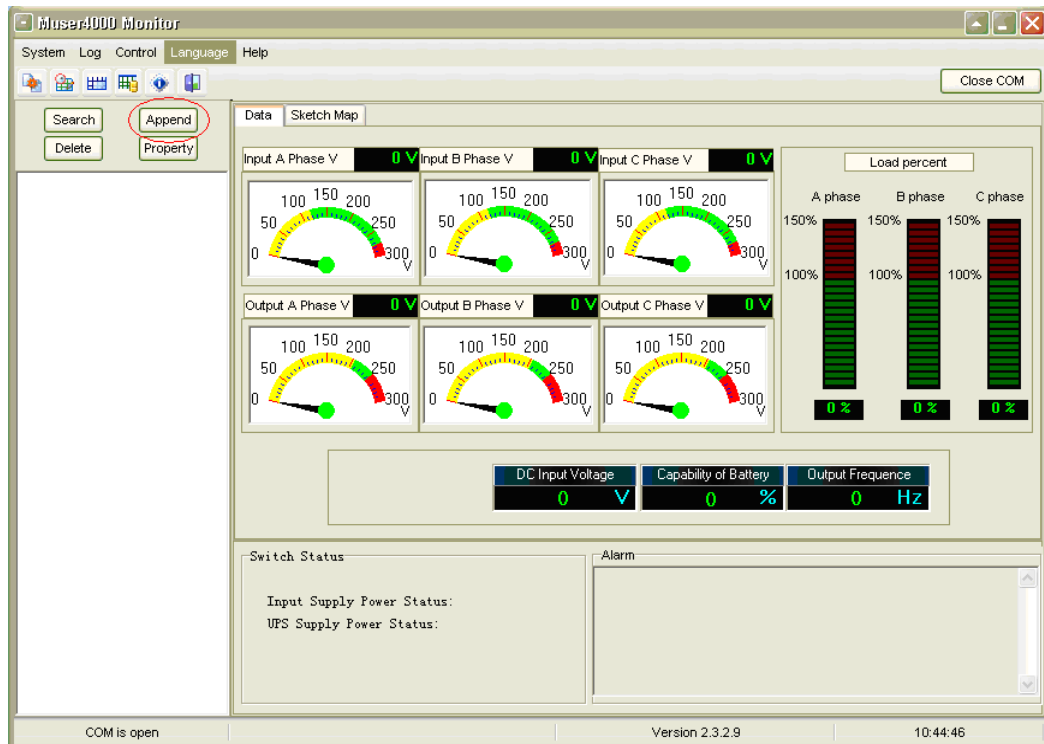

◆Put the UPS name into “Equipment Name”, and UPS’ ID address into “Equipment address”.

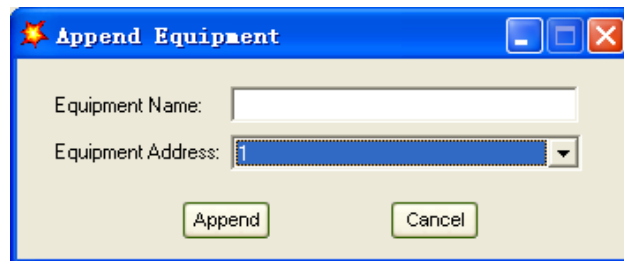

◆Click the button “Append”, then the connection between UPS & computer is accomplished.



CAUTION!

When the UPS worked on inverter. If you want to use PC to set the output voltage and frequency. Must shut down the inverter first

4 · Operation

4.1 Operation Modes

The UPS is a double-conversion on-line UPS that may operate in the following alternative modes :

◆Normal mode

The rectifier/charger derives power from the AC Mains and supplies DC power to the inverter while floating and boosting charge the battery simultaneously. Then, the inverter converts the DC power to AC and supplies to the load.

◆Battery mode (Stored Energy Mode)

If the AC mains input power fails, the inverter, which obtains power from the battery, supplies the critical AC load. There is no power interruption to the critical load. The UPS will automatically return to Normal Mode when AC recovers.

◆Bypass mode

If the inverter is out of order, or if overload occurs, the static transfer switch will be activated to transfer the load from the inverter supply to bypass supply without interruption to the critical load. In the event that the inverter output is not synchronized with the bypass AC source, the static switch will perform a transfer of the load from the inverter to the bypass with power interruption to the critical AC load. This is to avoid paralleling of unsynchronized AC sources. This interruption is programmable but typically set to be less than an electrical cycle e.g. less than 15ms (50Hz) or less than 13.33ms (60Hz).

◆ECO Mode

When the UPS is at AC Mode and the requirement to the load is not critical, the UPS can be set at ECO mode in order to increase the efficiency of the power supplied. At ECO mode, the UPS works at Line-interactive mode, so the UPS will transfer to bypass supply. When the AC is out of set window, the UPS will transfer from bypass to Inverter and supplies power from the battery, then the LCD shows all related information on the screen.

◆Parallel redundancy mode (system expansion)

To achieve a higher capacity and / or increase reliability, the outputs of up to four UPS modules can be programmed to operate in parallel and the built-in parallel controller in each UPS ensures automatic load sharing.

◆Maintenance mode (Manual Bypass)

A manual bypass switch is available to ensure continuity of supply to the critical load when the UPS is out of order or in repair, and this manual bypass switch bears for equivalent rated load.

4.2 Turn on/off UPS

4.2.1 Restart procedure



CAUTION!

Make sure grounding is properly done!

- ◆ Set the Battery Breaker to the “ON” position according to the user’s manual.
- ◆ Switch ON the power switch.

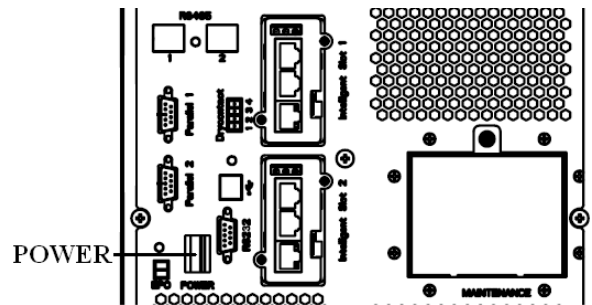

CAUTION !

Check to see if the load is safely connected with the output of the UPS. If the load is not ready to receive power from the UPS, make sure that it is safely isolated from the UPS output terminals

- ◆ Switch ON UPS input switch

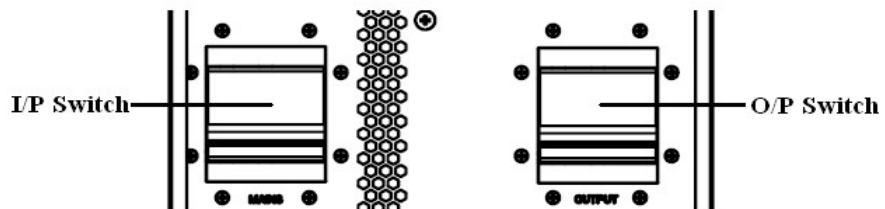

If the Rectifier input is within voltage range, the rectifier will start up in 30 seconds then the inverter will start up after then.

- ◆ Switch ON UPS output switch

If the rectifier fails at startup, the bypass LED will light up. When the inverter starts up, the UPS will transfer from bypass mode to inverter mode, then the bypass LED extinguishes and the inverter LED lights up.

No matter whether the UPS can work normally or not, all the status will be shown on the LCD display.

4.2.2 Test procedure



CAUTION!

The UPS is operating normally. It may take 60 seconds to boost up the system and perform self-test completely.

◆ Switch off the MAINS to simulate utility failure, the rectifier will turn off and the battery should feed the inverter without interruption. At this time, the LEDs of battery should be turned on.

◆ Switch on the MAINS to simulate utility recovery, the rectifier will restart automatically after 20 seconds and the inverter will supply to the load. It is suggested to use Dummy loads for testing. The UPS can be loaded up to its maximum capacity during load test ◦

4.2.3 MAINTENANCE BYPASS

To supply the load via Mains, you may simply active the internal mechanical bypass switch.



CAUTION!

The load is not protected by the UPS when the internal mechanical bypass system is active and the power is not conditioned.

Switch to mechanical bypass



CAUTION!

If the UPS is running normally and can be controlled through the display, carry out steps 1 to 5; otherwise, jump to Step 4.

- ◆ Open the cover of maintenance switch, the UPS turns to bypass mode automatically.
- ◆ Turn on MAINTANCE breaker;
- ◆ Open BATTERY breaker;
- ◆ Switch OFF the MAINS breaker,
- ◆ Switch OFF OUTPUT breaker;

At this time the bypass source will supply to the load through the MAINTENANCE breaker.

Switch to normal operation (from mechanical bypass)



CAUTION!

Never attempt to switch the UPS back to normal operation until you have verified that there are no internal UPS faults

- ◆ Switch ON the output breaker of the module.
- ◆ Switch ON the input breaker.

The UPS powers from the static bypass instead of the maintenance bypass, then the bypass LED will light up.

- ◆ Switch OFF the maintenance bypass breaker, then the output is supplied by the static bypass of the UPS.
- ◆ Put on the maintenance switch cover.

The rectifier will operate normally after 30 seconds. If the inverter works normally, the system will be transferred from bypass mode to normal mode.

4.2.4 Black (Cold) start procedure



CAUTION!

Follow these procedures when the input AC Utility Failure, but battery is normal

- ◆ Turn on the battery switch.
The battery will feed the Auxiliary power board.
- ◆ Turn on the Output switch.
- ◆ Switch ON the power switch (power will feed to auxiliary power board).

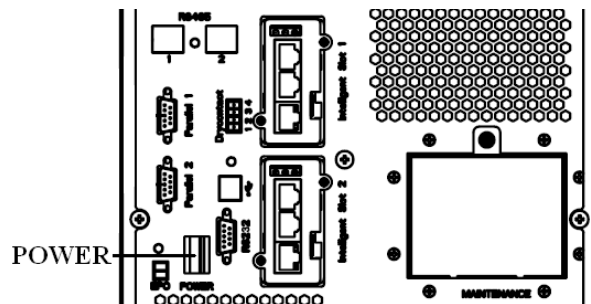

- ◆ Trigger the cold start button as the position 5 of the below drawing.

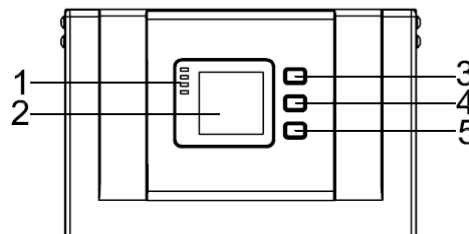

When battery normal, rectifier starts operation, 30s later, inverter starts and operates and battery LED on



CAUTION!

Please press the close start button after 30 seconds until closing the battery switch.

4.2.5 Shut down procedure



CAUTION!

This procedure should be followed to completely shut down the UPS and the LOAD. After all power switches, isolators and circuit breakers are opened, there will be no output.

- ◆ Open the BATTERY breaker ;
- ◆ Open the UPS door to easily access to the main power switch ;
- ◆ Switch OFF the input breaker.
- ◆ Open the OUTPUT power switch. The UPS shuts down ;
- ◆ To completely isolate the UPS from AC Mains, all input switches of Utility shall be completely off, which includes the ones for rectifier and bypass.
- ◆ The primary input distribution panel, which is often located far away from the UPS area, so a label should be posted to advise service personnel that the UPS circuit is under maintenance ◦



WARNING!

Wait for about 5 minutes for the internal D.C. bus bar capacitors to be completely discharged.

4.2.6 Parallel setting

- ◆ Connect the UPS with computer. Power on the UPS.
- ◆ Open Muser4000 software, after connecting with the UPS successfully, click “System”->“User Set”

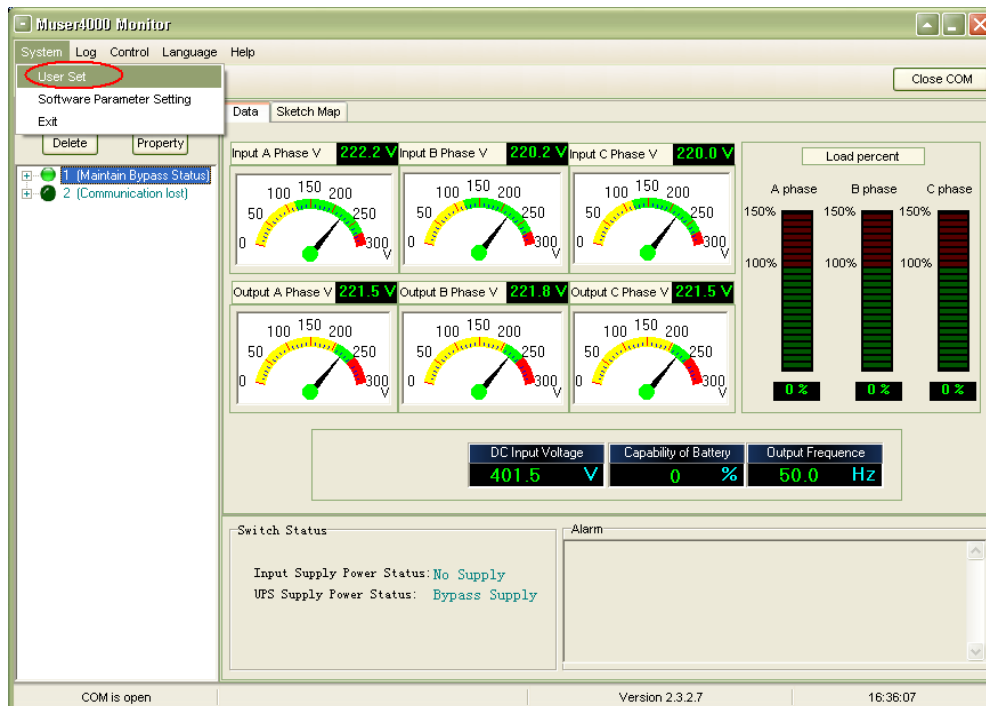

◆Click 'Set' at "User Set" window;

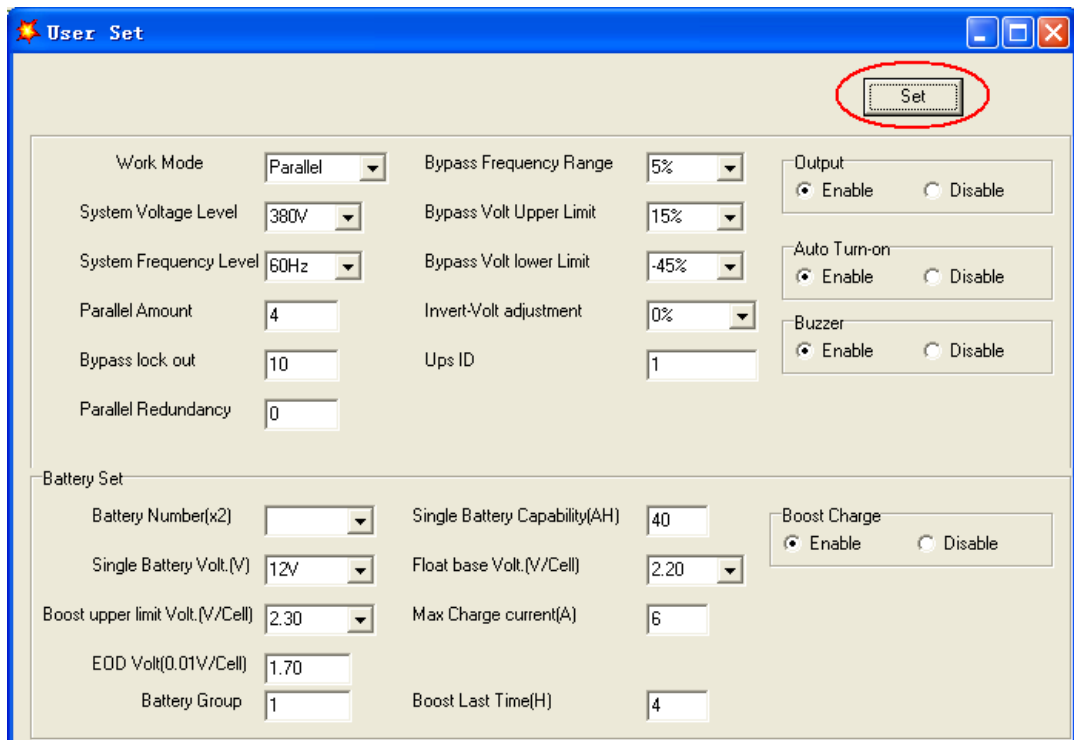

◆At the window of "Data Set", click "Work Mode",, choose "Parallel" for the value, then click "Set" as shown in below picture. If the UPS sounds a "beep", that means the setting is correct.

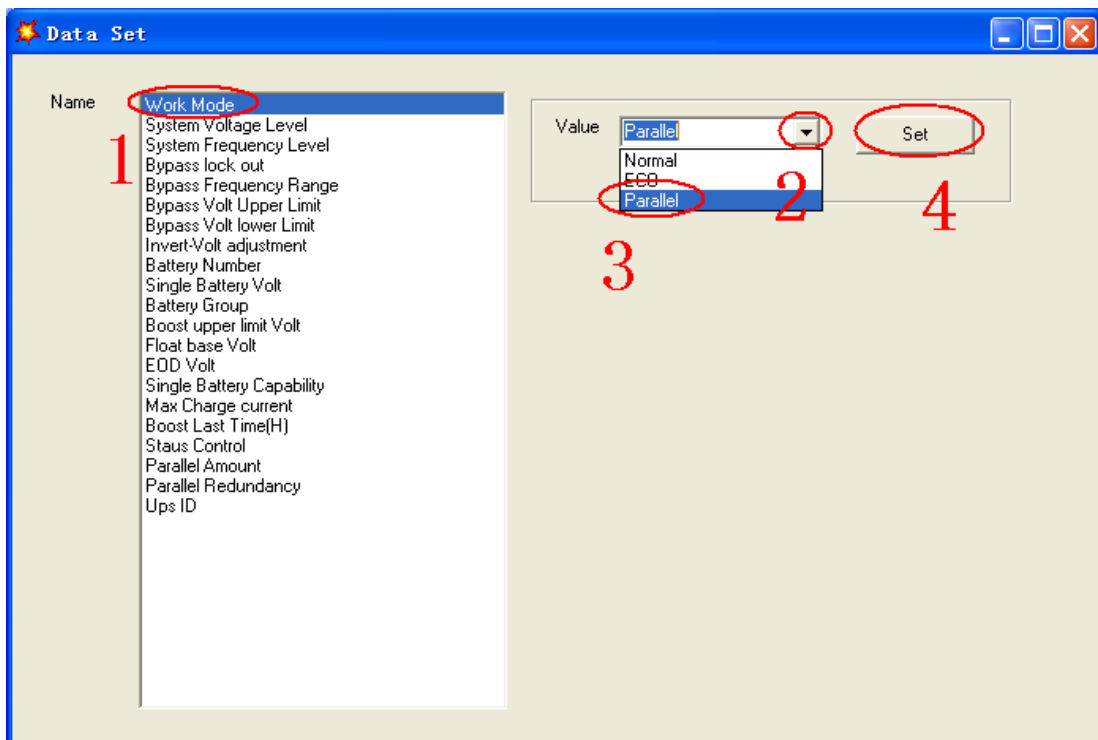

◆At the window of "Data Set", click "Ups ID", write a value for the parallel UPS ID at the right side, such as "1", then click "Set" as shown in below picture. If the UPS sounds a "beep", that

means the setting is correct.

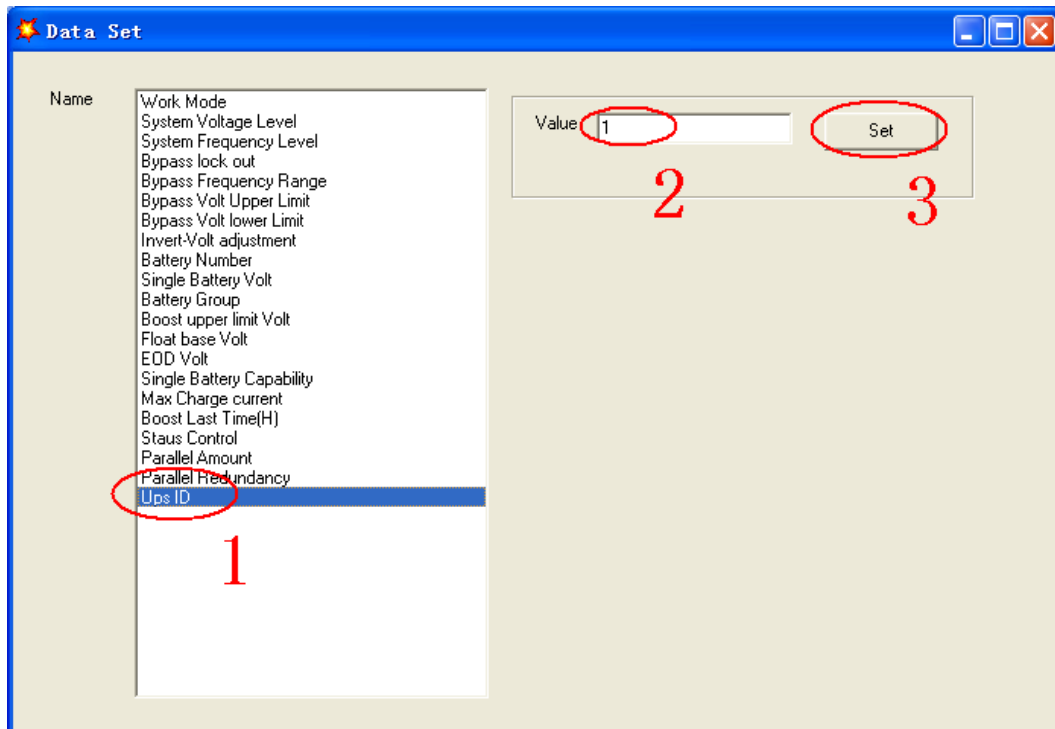

CAUTION !

After changing the parallel system ID, the connection between Muser4000 and equipment might be interrupted. If it occurs, please re-connect in accordance with the instruction described before.



CAUTION !

Parallel cable cannot be connected when setting the parallel parameters.

- ◆ After setting the UPS needed to be paralleled, power off all the UPS. Connect all the UPS according to “parallel cable installation”, and then power on the UPS.

4.3 The LCD Display

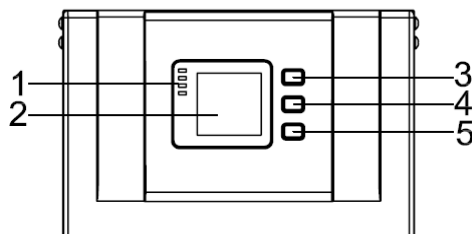

Overview of the operating panel of the UPS

(1)LED indicator (2)LCD display (3)Scroll button: enter to next item (4)Off button (5)On button

Introduction



CAUTION!

The display provides more functions than those described in this manual.

There are 17 interfaces available in the LCD display:

Item	Interface Description	Content Displayed
01	CODE	Operational status and mode
02	Input A(Input L1)	Voltage & Frequency
03	Input B(Input L2)	Voltage & Frequency
04	Input C(Input L3)	Voltage & Frequency
05	Bat. +	Voltage & Current
06	Bat. -	Voltage & Current
07	Backup time	Capacity & Time
08	Output A(Output L1)	Voltage & Frequency
09	Output B(Output L2)	Voltage & Frequency
10	Output C(Output L3)	Voltage & Frequency
11	Load A	Load
12	Load B	Load
13	Load C	Load
14	Total Load	Load
15	Temperature	battery temperature(need to connect batter sensor, Internal temperature and ambient temperature)
16	Software version & model	Version of rectifier software, version of inverter software, model
17	CODE	Alarm Code(Warning Message)

- 1) When the UPS is connecting with the Utility or Battery at cold start mode, it shows as drawing below:

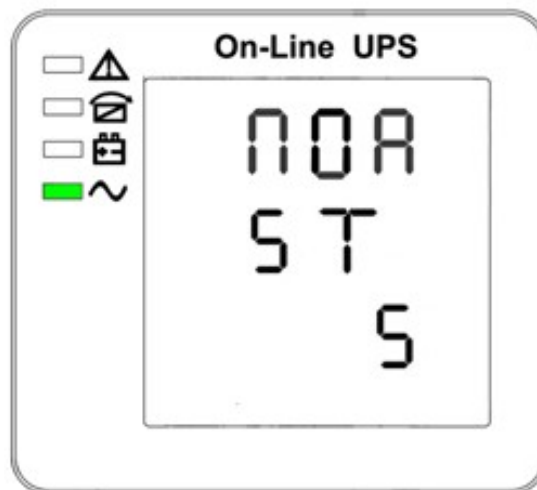

Operational Status and mode(When the UPS at single mode, it shows “NOR” or “ECO”, but If the UPS at parallel mode, it shows “PAL” instead.)

- 2) Press “scroll” button, the UPS goes to next page as shown below.

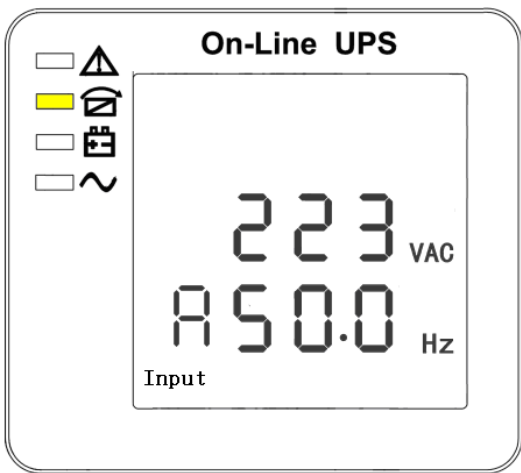

2.Phase A(L1) Input/Frequency

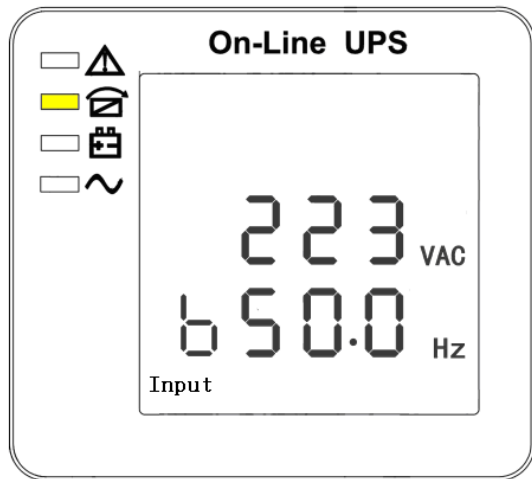

3. Phase B(L2) Input/Frequency

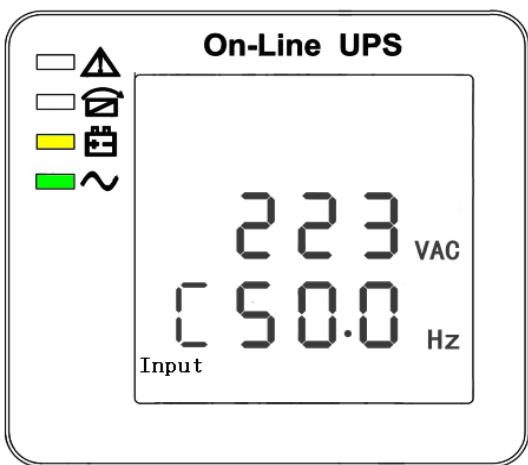

4. Phase C(L3) Input/Frequency

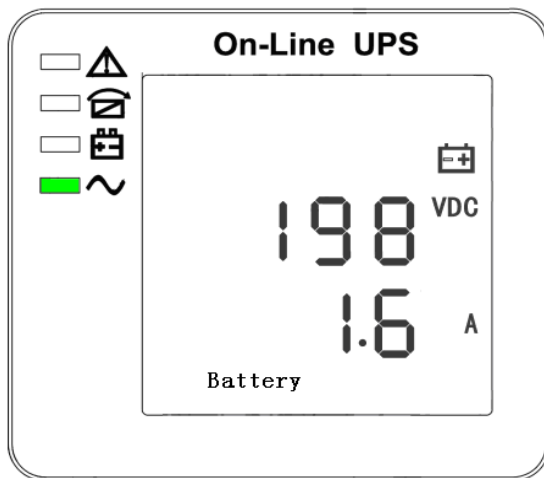

5. Bat +(Positive)

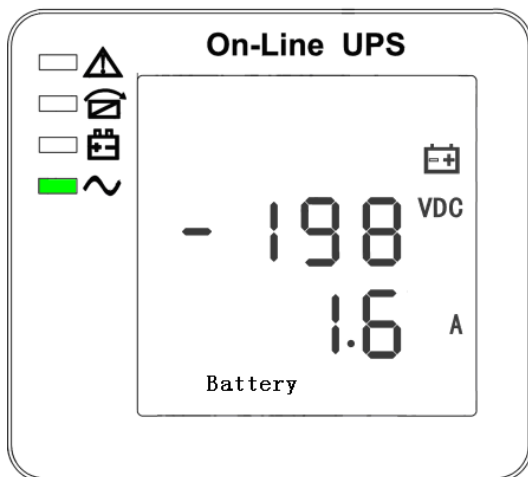

6. Bat -(Negative)

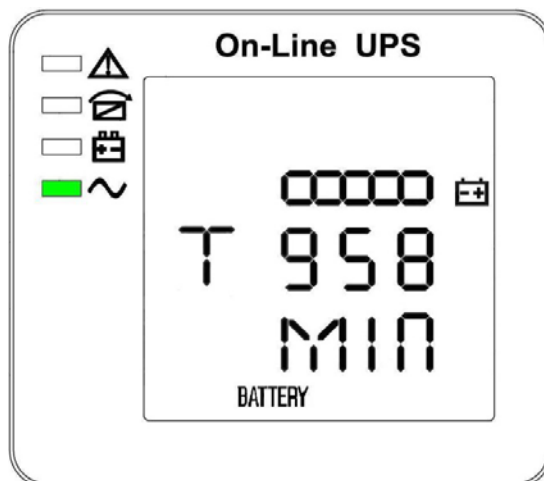

7. Backup time

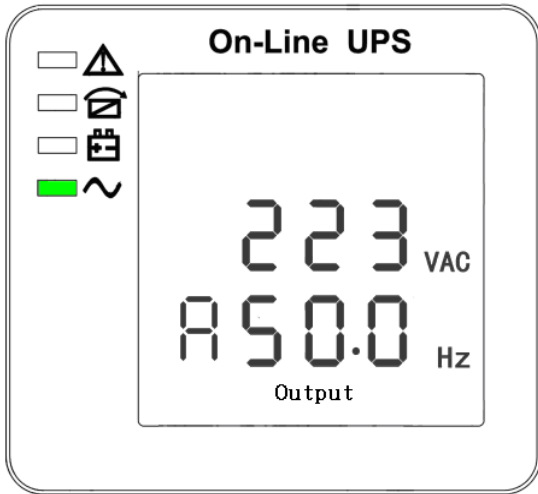

8. Phase A(L1) Output Voltage/Frequency

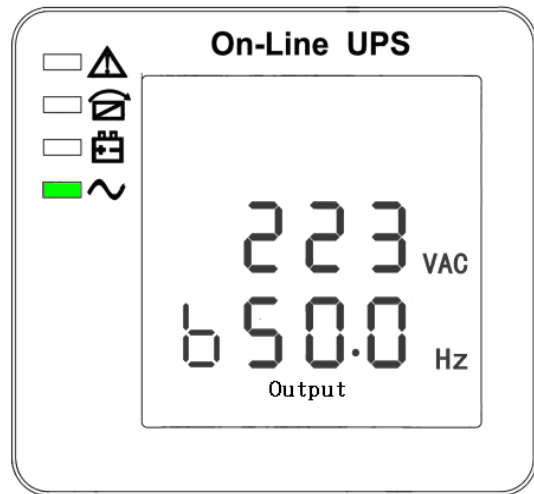

9. Phase B(L2) Output Voltage/Frequency

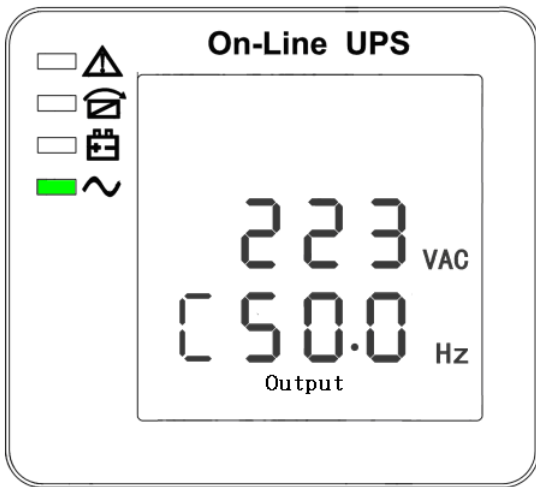

10. Phase C(L3) Output Voltage/Frequency

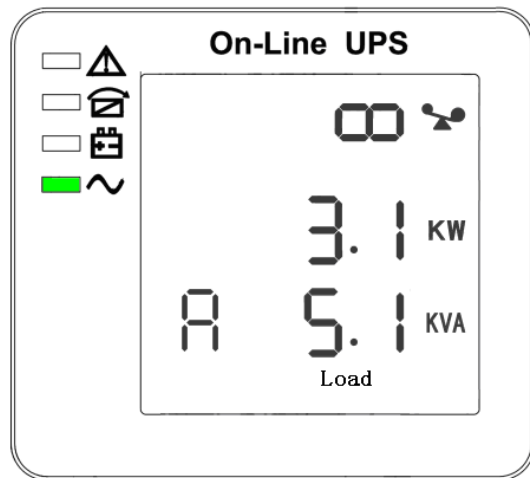

11. Phase A(L1) Load Capacity

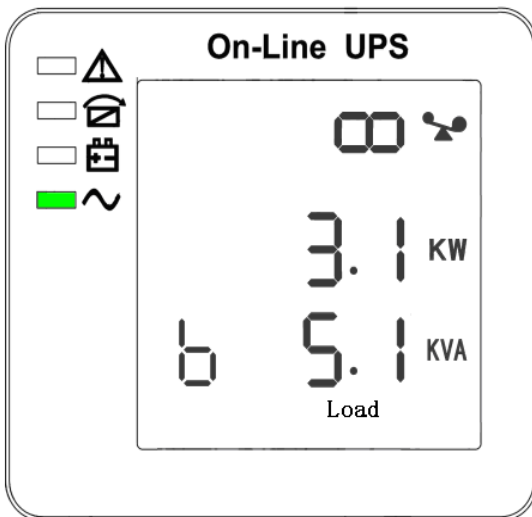

12. Phase B(L2) Load Capacity

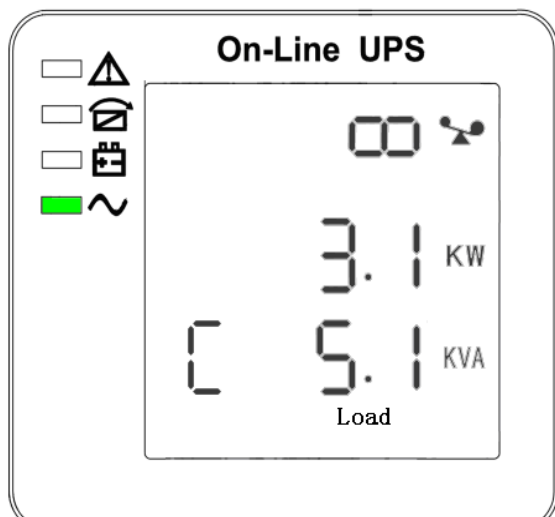

13. Phase C(L3) Load Capacity

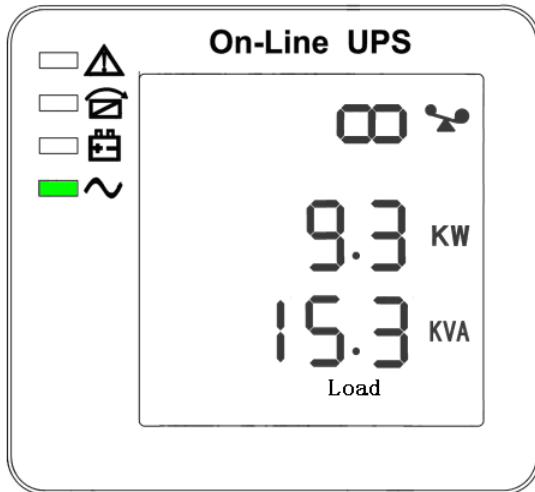

14.Total Load Capacity

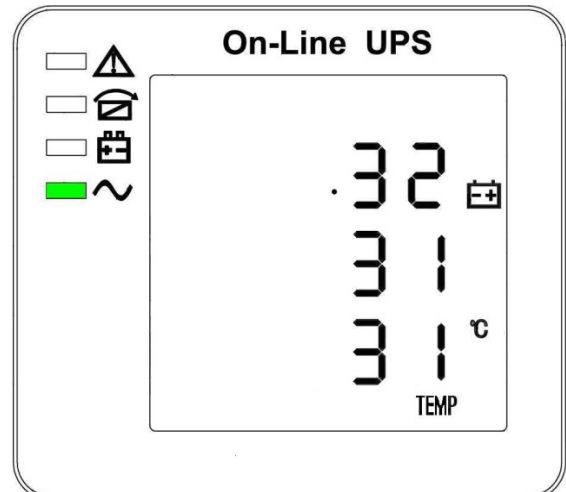

15. Temperature(battery/Internal and ambient temperature)

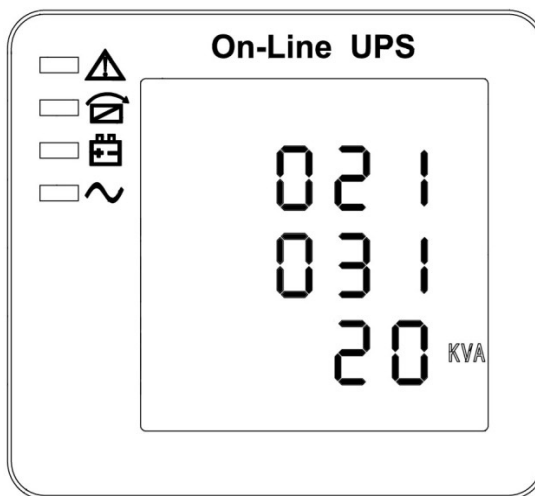

16. Software version & model

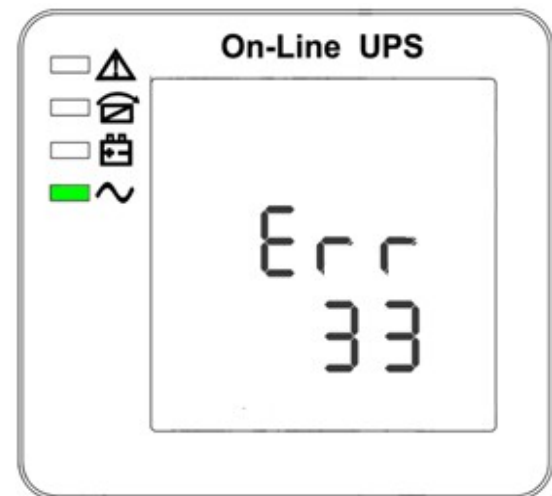

17.Alarm Code

If has battery charging, above 2-13 interface windows will also display the charging status at the same time as below:

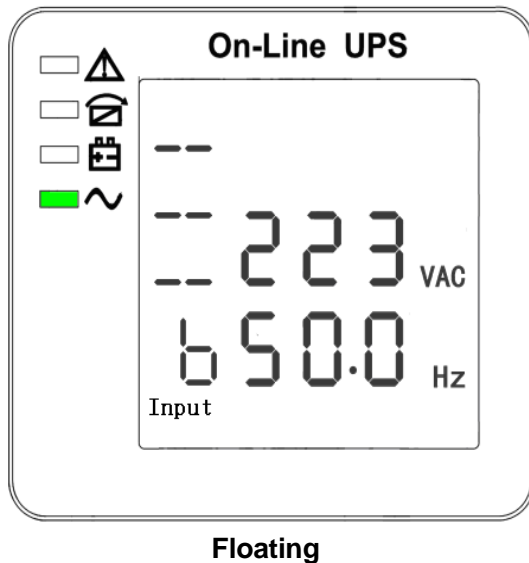
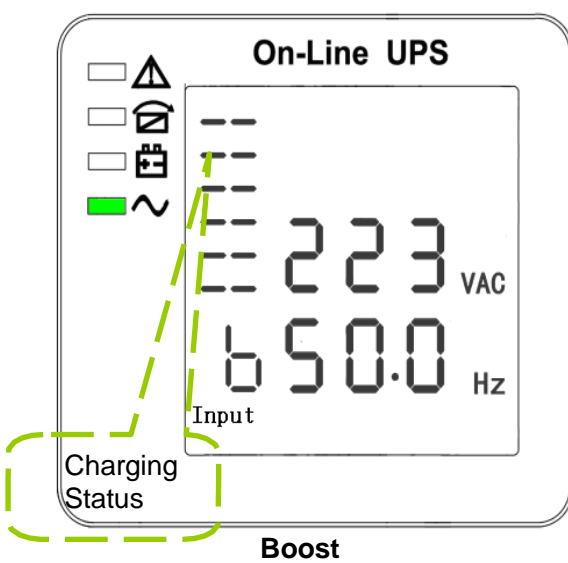

- 3) Pressing "scroll" button, you may circulate all messages from the first one to the last one then returns back to the first one and vice versa.
- 4) All alarm codes are present when abnormal behavior(s) occur(s).

4.4 Parameters setting

The setting function is controlled by 3 buttons (Enter ◡, Off ▲, On ▼): Enter ◡---goes into the setting page and value adjustment; Off ▲ & On ▼---for choosing different pages.

After the UPS turn ON, press buttons ◡ & ▲ for 2seconds and then goes into the setting interface page.

Note: Figure at left corner is the page number of the setting pages.

4.4.1 Mode setting

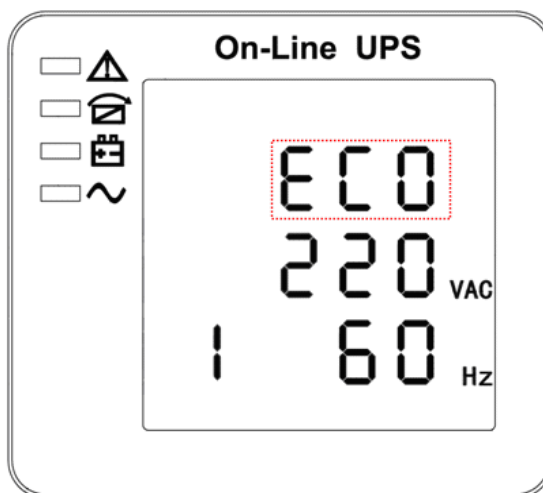

Mode setting (Note: Inside the broken-line is the flashing part.)

After entering the setting menu, it's mode setting defaulted, and the mode setting line flashing as in above picture. ①use button Enter◡ to choose different mode. There are 3 different modes for setting: ECO, PAL, NOR. ②press▲ or ▼ to exit the mode setting (save the mode setting), and goes to output voltage setting or parallel redundancy quantity setting.

4.4.2 Output voltage setting

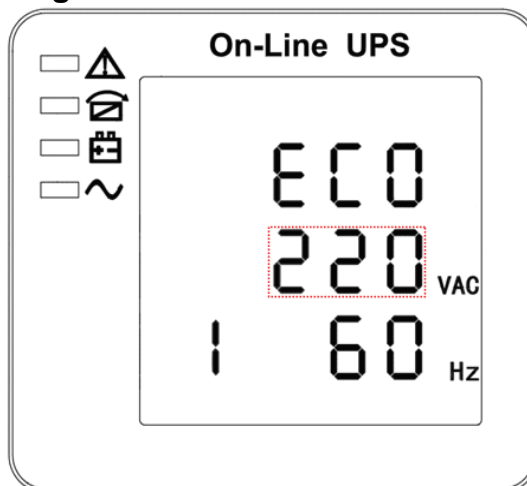

Output voltage setting (Note: Inside the broken-line is the flashing part.)

When under the mode setting press On▼ or when under frequency setting press Off▲, it goes to the output voltage setting. The output voltage line flashes as in above picture. ①use button Enter◡ to choose the different output voltage. There are 3 different voltages---220, 230, 240. ②press▲ or ▼ to exit the output voltage setting (save the output voltage setting) and goes to mode setting or frequency setting.



CAUTION!

When powered by inverter, it is necessary to turn off the inverter before setting voltage and frequency level.

4.4.3 Frequency setting

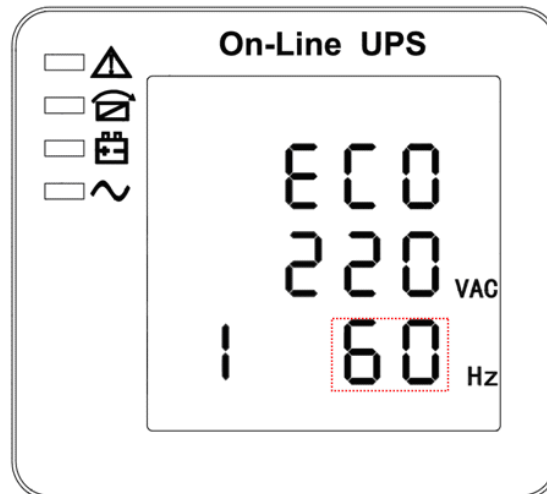

Frequency setting (Note: Inside the broken-line is the flashing part.)

When under the output voltage setting press On▼ or when under battery capacity setting press Off▲, it goes to the frequency setting. The frequency line flashes as in above picture. ①use button Enter↵ to choose the different frequency. There are 2 different frequency---50,60HZ. ②press▲ or ▼ to exit the frequency setting (save the frequency setting) and goes to output voltage setting or battery capacity setting.



CAUTION!

When powered by inverter, it is necessary to turn off the inverter before setting voltage and frequency level.

4.4.4 Battery capacity setting

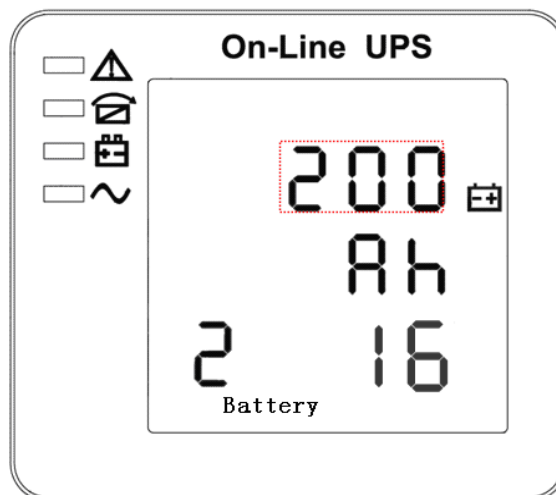

Battery capacity setting (Note: Inside the broken-line is the flashing part.)

When under the frequency setting press On▼ or when under battery quantity setting press Off▲, it goes to the battery capacity setting. The battery capacity line flashes as in above picture. ① use button Enter↵ to choose the different battery capacity. Battery capacity range is 1-200Ah. (Note: long-press of Enter↵ can adjustment battery capacity quickly.) ②press▲ or ▼ to exit the battery capacity setting (save the capacity setting) and goes to frequency setting or battery quantity setting.

4.4.5 Battery quantity setting

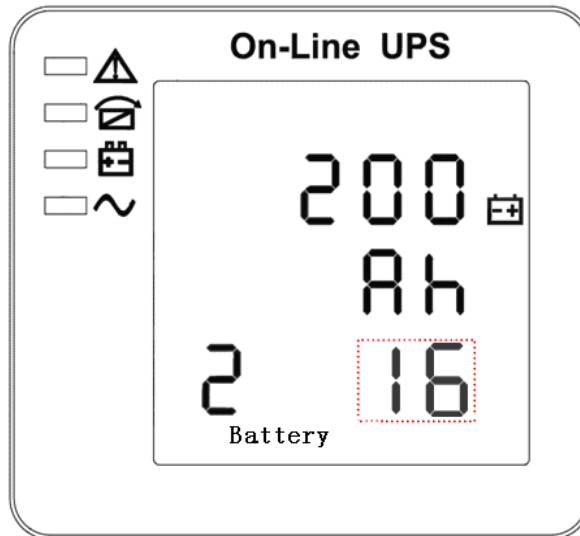

Battery quantity setting (Note: Inside the broken-line is the flashing part.)

When under the battery capacity setting press On▼ or when under bypass voltage upper limit setting press Off▲, it goes to the battery quantity setting. The battery quantity line flashes as in above picture. ①use button Enter↵ to choose the different battery quantity. Battery quantity range is 16,18,20. ②press▲ or ▼ to exit the battery quantity setting (save the battery quantity setting) and goes to battery capacity setting or bypass voltage upper limit setting.

4.4.6 Bypass voltage upper limit setting

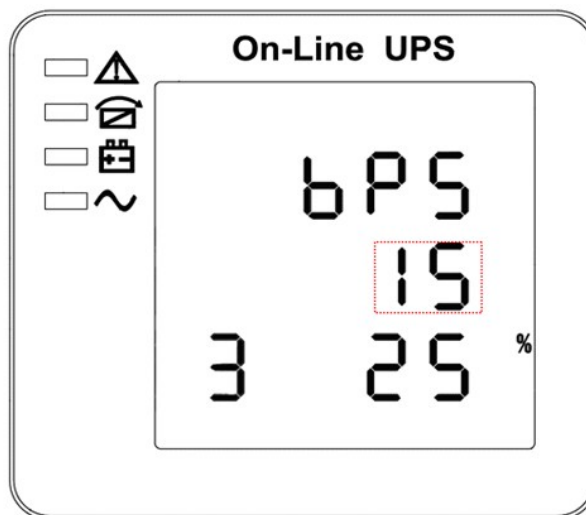

Bypass voltage upper limit setting (Note: Inside the broken-line is the flashing part.)

When under the battery quantity setting press On▼ or when under bypass voltage lower setting press Off▲, it goes to the bypass upper limit setting. The bypass upper limit line flashes as in above picture. ①use button Enter↵ to set the different bypass voltage upper limit. The bypass voltage upper limit range is 5%,10%,15%,25%(25% only for 220V output). ②press▲ or ▼ to exit the bypass voltage upper limit setting (save the bypass voltage upper limit setting) and goes to battery quantity setting or bypass voltage lower limit setting.

4.4.7 Bypass voltage lower limit setting

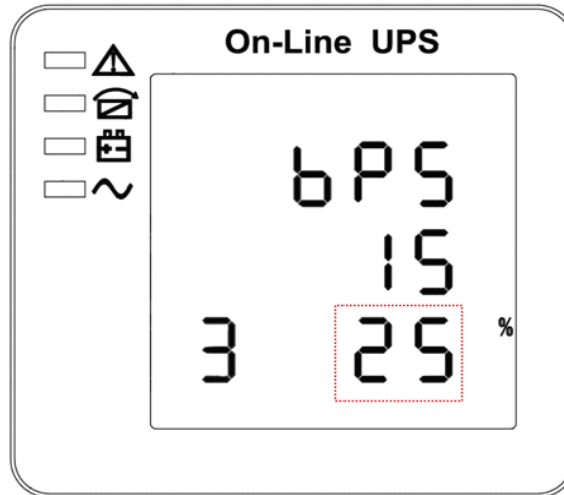

Bypass voltage lower limit setting (Note: Inside the broken-line is the flashing part.)

When under the bypass voltage upper limit setting press On ▼ or when under parallel ID setting press Off ▲, it goes to the bypass lower limit setting. The bypass lower limit line flashes as in above picture. ("-" for negative, positive does not have any symbol.) ①use button Enter ⏏ to set the different bypass voltage lower limit. The bypass voltage lower limit range is 20%,30%,45%. ②press ▲ or ▼ to exit the bypass voltage lower limit setting (save the bypass voltage lower limit setting) and goes to bypass upper limit setting or parallel ID setting.

4.4.8 Buzzer Mute Setting

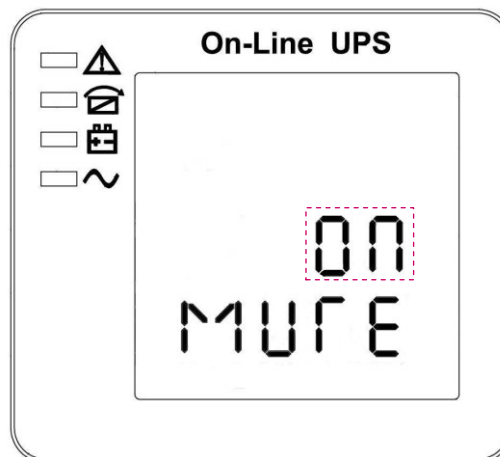

Buzzer Settings (note: red dashed box is the scintillation part)

Press key ON under bypass volt-lo setting or press key OFF into buzzer setting under Parallel operation ID setting. The scintillation of setting state shows as Figure 14 (Note: ON shows MUTE, OFF shows NO MUTE).①press button Enter ⏏ for Mute Cycle Settings, mute choice has On and Off. ②press button ON or OFF exits mute Setting (save mute setting state) and change to bypass volt-lo setting or parallel operation ID Settings.

4.4.9 Parallel ID setting

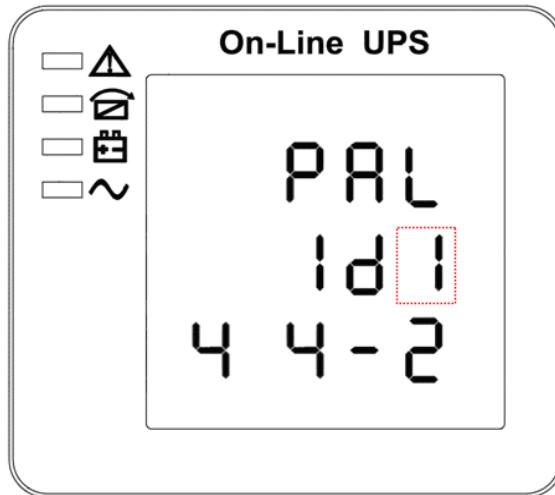

Parallel ID setting (Note: Inside the broken-line is the flashing part.)

When under the bypass voltage lower limit setting press On▼ or when under parallel quantity setting press Off▲, it goes to the parallel ID setting. The parallel ID flashes as in above picture. ① use button Enter↵ to set the different parallel ID. The parallel ID range is 1~4. ②press▲ or ▼ to exit the parallel ID setting (save the parallel ID setting) and goes to bypass lower limit setting or parallel quantity setting.



CAUTION !

Parallel cable cannot be connected when setting the parallel parameters.

4.4.10 Parallel quantity setting

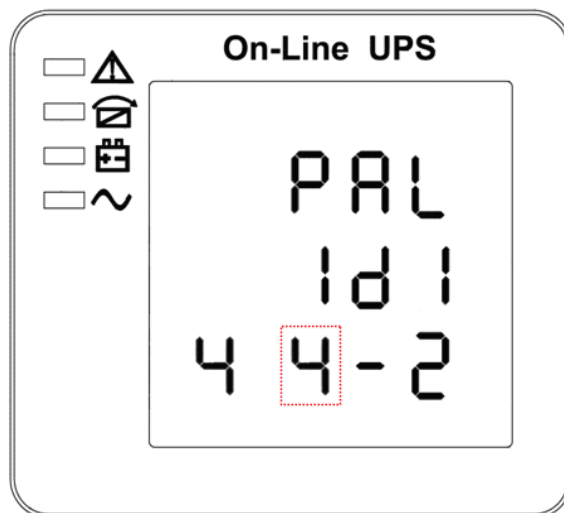

Parallel quantity setting (Note: Inside the broken-line is the flashing part.)

When under the parallel ID setting press On▼ or when under parallel redundancy quantity setting press Off▲, it goes to the parallel quantity setting. The parallel quantity flashes as in above picture. ①use button Enter↵ to set the parallel quantity. The parallel quantity range is 2~4. ② press▲ or ▼ to exit the parallel quantity setting (save the parallel quantity setting) and goes to parallel ID setting or parallel redundancy quantity setting.

4.4.11 Parallel redundancy quantity setting

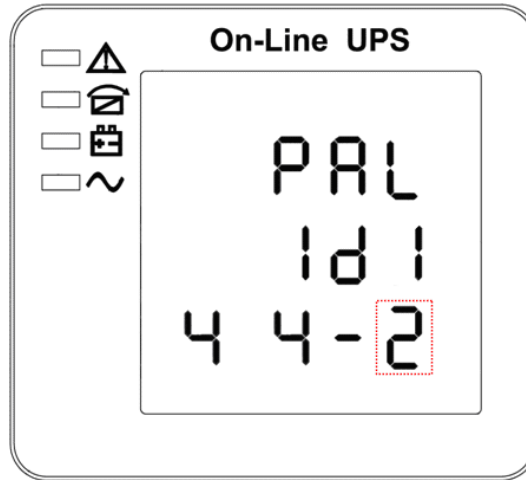

Parallel redundancy quantity setting (Note: Inside the broken-line is the flashing part.)

When under the parallel quantity setting press On▼, it goes to the parallel redundancy quantity setting. The parallel redundancy quantity flashes as in above picture. ①use button Enter↵ to set the parallel redundancy quantity. The parallel redundancy quantity range is 0~3. ②press▲ to go to parallel quantity setting, or ▼ to exit the mode setting. Then UPS LCD panel setting is accomplished.

4.5 Display Messages/Troubleshooting

This section lists the event and alarm messages that the UPS might display. The messages are listed in alphabetical order. This section is listed with each alarm message to help you troubleshoot problems.

Display messages

Operational Status and Mode(s)

Code (ST)	Information stand for	LED			
		Fault	Bypass	Battery	Inverter
1	Initialized	EXTINGUISH	EXTINGUISH	EXTINGUISH	EXTINGUISH
2	Standby Mode	EXTINGUISH	EXTINGUISH	X	EXTINGUISH
3	No Output	EXTINGUISH	EXTINGUISH	X	EXTINGUISH
4	Bypass Mode	EXTINGUISH	LIGHT	X	EXTINGUISH
5	Utility Mode	EXTINGUISH	EXTINGUISH	X	LIGHT
6	Battery Mode	EXTINGUISH	EXTINGUISH	LIGHT	EXTINGUISH
7	Battery Self-diagnostics	EXTINGUISH	EXTINGUISH	LIGHT	EXTINGUISH
8	Inverter is starting up	EXTINGUISH	X	X	EXTINGUISH
9	ECO Mode	EXTINGUISH	X	X	X
10	EPO Mode	LIGHT	EXTINGUISH	X	EXTINGUISH
11	Maintenance Bypass Mode	EXTINGUISH	EXTINGUISH	EXTINGUISH	EXTINGUISH
12	Fault Mode	LIGHT	X	X	X

CAUTION : "X" means it is determined by other conditions

Alarm Information

Fault code (Err)	UPS Alarm Warning	Buzzer	LED
1	Rectifier Fault	Beep continuously	Fault LED lit
2	Inverter fault(Including Inverter bridge is shorted)	Beep continuously	Fault LED lit
3	Inverter Thyristor short	Beep continuously	Fault LED lit
4	Inverter Thyristor broken	Beep continuously	Fault LED lit
5	Bypass Thyristor short	Beep continuously	Fault LED lit
6	Bypass Thyristor broken	Beep continuously	Fault LED lit
7	Fuse broken	Beep continuously	Fault LED lit
8	Parallel relay fault	Beep continuously	Fault LED lit
9	Fan fault	Beep continuously	Fault LED lit
10	Reserve	Beep continuously	Fault LED lit
11	Auxiliary power fault	Beep continuously	Fault LED lit
12	Initializion fault	Beep continuously	Fault LED lit
13	P-Battery Charger fault	Beep continuously	Fault LED lit
14	N-Battery Charger fault	Beep continuously	Fault LED lit
15	DC Bus over voltage	Beep continuously	Fault LED lit
16	DC Bus below voltage	Beep continuously	Fault LED lit
17	DC bus unbalance	Beep continuously	Fault LED lit
18	Soft start failed	Beep continuously	Fault LED lit
19	Rectifier Over Temperature	Twice per second	Fault LED lit
20	Inverter Over temperature	Twice per second	Fault LED lit
21	Reserve	Twice per second	Fault LED lit
22	Battery reverse	Twice per second	Fault LED lit
23	Cable connection error	Twice per second	Fault LED lit
24	CAN comm. Fault	Twice per second	Fault LED lit
25	Parallel load sharing fault	Twice per second	Fault LED lit
26	Battery over voltage	Once per second	Fault LED blinking
27	Mains Site Wiring Fault	Once per second	Fault LED blinking
28	Bypass Site Wiring Fault	Once per second	Fault LED blinking
29	Output Short-circuit	Once per second	Fault LED blinking
30	Rectifier over current	Once per second	Fault LED blinking
31	Bypass over current	Once per second	BPS LED blinking
32	Overload	Once per second	INV or BPS LED blinking
33	No battery	Once per second	Battery LED blinking
34	Battery under voltage	Once per second	Battery LED blinking
35	Battery low pre-warning	Once per second	Battery LED blinking
36	Internal Communication Error	Once per 2 seconds	Fault LED blinking
37	DC component over limit.	Once per 2 seconds	INV LED blinking
38	Parallel Overload	Once per 2 seconds	INV LED blinking
39	Mains volt. Abnormal	Once per 2 seconds	Battery LED lit
40	Mains freq. abnormal	Once per 2 seconds	Battery LED lit
41	Bypass Not Available		BPS LED blinking
42	Bypass unable to trace		BPS LED blinking
43	Inverter on invalid		

44	Reserve		
45	inverter not on		

4.6 Options

SNMP card: internal SNMP / external SNMP optional

- ◆ Loosen the 2 torque screws (on each side of the card).
- ◆ Carefully pull out the card. Reverse the procedure for re-installation

The slot called SNMP supports the MEGAtec protocol. We advise that NetAgent II-3 port is also a tool to remotely monitor and manage any UPS system

NetAgent II-3Ports supports the Modem Dial-in(PPP) function to enable the remote control via the internet when the network is unavailable .

In addition to the features of a standard NetAgent Mini, NetAgent II has the option to add NetFeeler Lite to detect temperature, humidity, smoke and security sensors. Thus, making NetAgent II a versatile management tool. NetAgent II also supports multiple languages and is setup for web-based auto language detection.

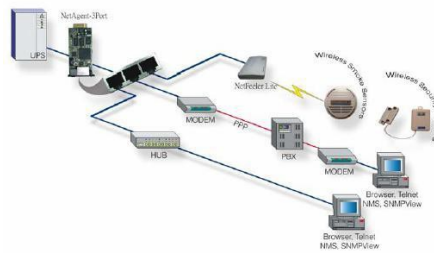

Typical topology of the UPS Network Management

Relay card

The card is used for providing the interface for UPS peripheral monitoring. The contact signals can reflect UPS running status. The card is connected to peripheral monitoring devices via DB9 female to facilitate the effective monitoring of the real-time status of UPS and timely feedback the status to monitor when abnormal situation occurs (such as UJPS failure, mains interruption, UPS bypass and ect.). It is installed in the intelligent slot of the UPS.

The relay card includes 6 output ports and one input port. Please refer to the following table for detail.



DB9 interface: Connect to upper control terminal. The definition of the pins is defined as below:

Pin-out	Function description	Input/Output
1	UPS Failure	Output
2	Summary Alarm	Output
3	GND	
4	Remote Shutdown	Input
5	Common	
6	Bypass	Output
7	Battery Low	Output
8	UPS ON	Output
9	Utility Failure	Output



Appendix 1 Specifications

Model		10KVA(S/H)	15KVA(S/H)	20KVA(S/H)
Capacity		10KVA 9KW	15KVA 13.5KW	20KVA 18KW
Input	Phase		3 Phase 4 Wires and Ground	
	Rated Voltage		380/400/415Vac	
	Voltage Range		208~478Vac	
	Frequency Range		45-55Hz at 50Hz/54-66Hz at 60Hz (auto sensing)	
	Power Factor		≥0.99	
	Current THDi		≤3%(100% nonlinear load)	
	Bypass Voltage Range		Max. voltage: 220Vac: +25%(optional +5%,+10%,+15%) 230Vac: +20%(optional +10%,+15%) 240Vac: +15%(optional +10%) Min. voltage: -45% (optional -20%、-30%) Frequency protection range: ±10%	
	Generator Input		Support	
Output	Phase		3 Phase 4 Wires and Ground	
	Rated Voltage		380/400/415Vac	
	Power Factor		0.9	
	Voltage Regulation		±1%	
	Frequency	Utility Mode	±1% ±2% ±4% ±5% ±10% of the rated frequency(optional)	
		Battery Mode	(50/60±0.2%)Hz	
	Crest Factor		3:1	
THD		≤2% with linear load ≤5% with non linear load		
Efficiency		≥93.5% at normal mode	≥94.5% at normal mode	
Battery	Voltage		Standard unit: ±120Vdc (20pcs 12V9AH); Long run unit : ±96V/±108V/±120Vdc (16/18/20pcs optional)	Standard unit: ±120Vdc (2x20pcs 12V9AH); Long run unit Optional Voltage: ±96V/±108V/±120Vdc (16/18/20pcs optional)
	Charge Current(A) (charge current can be set according to battery capacity installed)		Standard unit: 1.35A Long run unit: Max. current 10A	Standard unit: 2.7A Long run unit: Max. current 10A
Transfer Time		Utility to Battery : 0ms; Utility to bypass: 0ms		
Protection	Overload	AC Mode	Load≤110%: last 60min, ≤125%: last 10min, ≤150%: last 1min, ≥150% change to bypass immediately。	
		Bat. Mode	Load≤110%: last 10min, ≤125%: last 1min, ≤150%: last 5S, ≥150% shut down UPS immediately。	
	Bypass Mode	Breaker 20A	Breaker 32A	Breaker 40A
Short Circuit		Hold Whole System		

	Overheat	Line Mode: Switch to Bypass; Backup Mode: Shut down UPS immediately		
	Battery Low	Alarm and Switch off		
	Self-diagnostics	Upon Power On and Software Control		
	EPO(optional)	Shut down UPS immediately		
	Battery	Advanced Battery Management		
	Noise Suppression	Complies with EN62040-2		
Alarms	Audible & Visual	Line Failure, Battery Low, Overload, System Fault		
Display	Status LED & LCD	Line Mode, Bypass Mode, Battery Low, Battery Bad, Overload & UPS Fault		
	Reading On the LCD	Input Voltage, Input Frequency, Output Voltage, Output Frequency, Load Percentage, Battery Voltage & Inner Temperature		
Communication Interface		USB, RS485, Parallel (optional), Coupler dry contact, Intelligent slot, SNMP card (optional), Relay card (optional)		
Environment	Operating Temperature	0°C ~ 40°C		
	Storage Temperature	-25°C ~ 55°C		
	Humidity	0~95% non condensing		
	Altitude	< 1500m.When>1500m,lower the rated power for use		
Other	Unit Dimensions(D×W×H)	828x250x868		
	Weight (Kg)	115/57	170/63	171/64
Safety Conformance		CE,EN/IEC 62040-2,EN/IEC 62040-1-1		

Appendix 2 Problems and Solution

In case the UPS can not work normally, it might be wrong in installation, wiring or operation. Please check these aspects first. If all these aspects are checked without any problem, please consult with local agent right away and provide below information.

- (1) Product model name and serial number.
- (2) Try to describe the fault with more details, such as LCD display info, LED lights status, etc.

Read the user manual carefully, it can help a lot for using this UPS in the right way. Some FAQ (frequently asked questions) may help you to troubleshoot your problem easily.

No.	Problem	Possible reason	Solution
1	Utility is connected but the UPS can not be powered ON.	Input power supply is not connected; Input voltage low; The input switch of the module is not switched on .	measure if the UPS input voltage/frequency are within the window. Check if all modules input are switched on
2	Utility normal but Utility LED does not light on, and the UPS operates at battery mode	The input breakers of the Modules are not switched on; input cable is not well connected	Switch on the input breaker; Make sure the input cable is well connected.

3	The UPS does not indicate any failure, but output do not have voltage	Output cable does not well connected; Output breaker do not switch on	Make sure the output cable is well connected; Switch on the output breaker.
4	Utility LED is flashing	Utility voltage exceeds UPS input range.	If the UPS operates at battery mode, please pay attention to the remaining backup time needed for your system.
5	Battery LED is flashing but no charge voltage and current	Battery breaker does not switch on, or batteries are damaged, or battery is reversely connected. battery number and capacity are not set correctly.	Switch on the battery breaker. If batteries are damaged, need to replace whole group batteries, Connect the battery cables correctly; Go to LCD setting of the battery number and capacity, set the correct data.
6	Buzzer beeps every 0.5 seconds and LCD display "output overload"	Overload	remove some load
7	Buzzer long beeps, LCD display "29"fault code	The UPS output is in short circuit	Make sure the load is not in short circuit, then restart the UPS.
8	The UPS only works on bypass mode	The UPS is set to ECO mode, or the transfer times to bypass mode are limited.	Set the UPS working mode to Single Module type(non-parallel) or to reset the times of transferring to bypass or re-start the UPS
9	Can not Black start	Battery switch is not properly closed ; Battery fuse is not open ; Or Battery low ; Battery quantity set wrong; Power breaker in the rear panel not switch ON.	Close the battery switch ; Change the fuse ; Recharge the battery ; Power ON the UPS with AC to set the battery quantity & quantity; Switch on the power breaker.
10	Buzzer beeps continuously and LCD indicates 1,3,5,9,15, etc fault codes	UPS is out of order	Consult with your local agent for repair

Appendix 3 USB communication port definition

Definition of port :

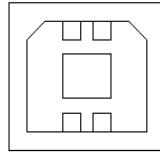

Connection between PC USB port and UPS USB port.

PC USB port	UPS USB port	Description
Pin 1	Pin 1	PC : +5V
Pin 2	Pin 2	PC : DPLUS signal
Pin 3	Pin 3	PC : DMINUS signal
Pin 4	Pin 4	Signal ground

Available function of USB

- ◆ Monitor UPS power status ◦
- ◆ Monitor UPS alarm info ◦
- ◆ Monitor UPS running parameters ◦
- ◆ Timing off/on setting ◦

Communication data format

Baud rate ----- 9600bps

Byte length ----- 8bit

End bit ----- 1bit

Parity check -----non



CAUTION !

USB, RS232 and RS485 interface cannot be used at the same time, you can only use one of them at one time.

Appendix 4 RS232 communication port definition

Definition of Male port :

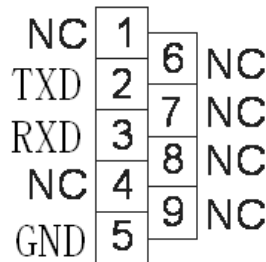

Connection between PC RS232 port and UPS RS232 port

PC RS232 port	UPS RS232 port	
Pin 2	Pin 2	UPS send , PC receive
Pin 3	Pin 3	PC send , UPS receive
Pin 5	Pin 5	ground

Available function of RS232

- ◆ Monitor UPS power status ◦
- ◆ Monitor UPS alarm info ◦
- ◆ Monitor UPS running parameters ◦
- ◆ Timing off/on setting ◦

RS-232 communication data format

Baud rate ----- 9600bps

Byte length ----- 8bit

End bit ----- 1bit

Parity check -----non



CAUTION !

USB, RS232 and RS485 interface cannot be used at the same time, you can only use one of them at one time.

Appendix 5 RS485 communication port definition

Definition of port :

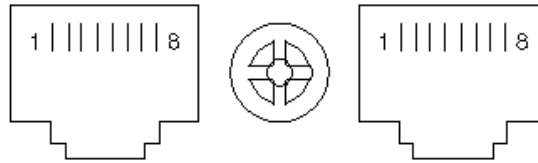

Connection between the Device's RS485 port and UPS RS485 port.

device (RJ45)	UPS (RJ45)	Description
Pin 1/5	Pin 1/5	485+ "A"
Pin 2/4	Pin 2/4	485 -"B"

Available function of RS485

- ◆ Monitor UPS power status ◦
- ◆ Monitor UPS alarm info ◦
- ◆ Monitor UPS running parameters ◦
- ◆ Timing off/on setting ◦



CAUTION !

USB, RS232 and RS485 interface cannot be used at the same time, you can only use one of them at one time.

Appendix 6 BAT_T communication port definition

Definition of port :

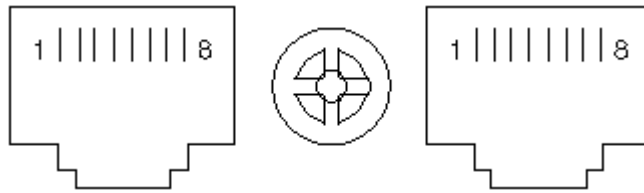

Temperature sensor's RS485 port and UPS's RS485 port.

Temperature sensor (RJ45)	UPS2 BAT_T (RJ45)	Description
Pin 1/5	Pin 1/5	TX
Pin 2/4	Pin 2/4	RX
Pin 7	Pin 7	12V
Pin 8	Pin 8	GND

Available function of BAT_T

- ◆ Battery environment temperature monitoring.
- ◆ Charging voltage modulation depending on batteries' temperature

Appendix 7 Dry contact port communication port definition

Definition of Male port :

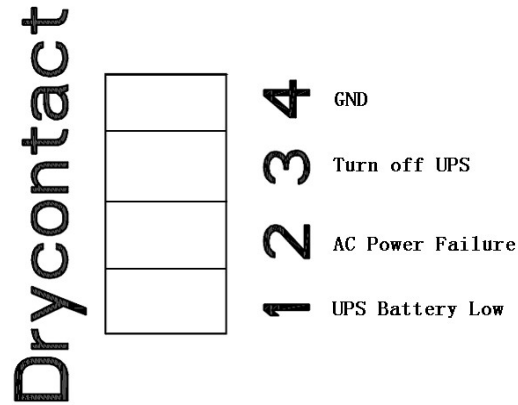

Instruction:

UPS	Instruction
Pin1	UPS Battery Low
Pin2	AC Power Failure
Pin3	Turn off UPS
Pin4	Common GND

Function description:

- ◆ Monitor UPS status;
- ◆ Monitor UPS battery status;
- ◆ Shutdown UPS.

Appendix 8 REPO instruction

Definition of port :

Connection diagram :

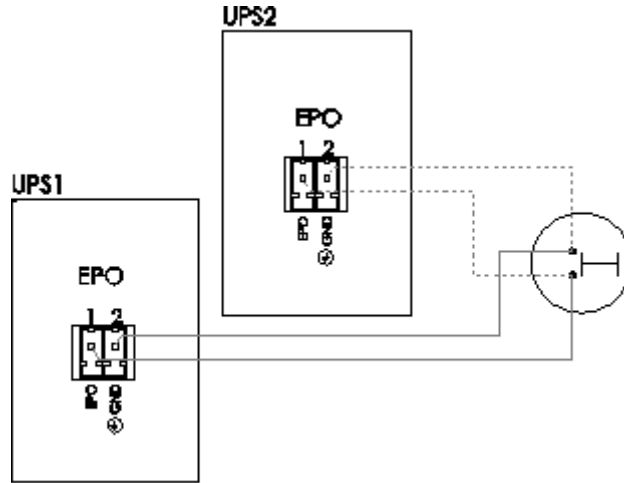

Connection between the button and UPS REPO port.

Button	UPS REPO	Description
Pin 1	Pin 1	EPO
Pin 2	Pin 2	GND

- ◆ A remote emergency stop switch (Dry contact signal and “normally open” - not provided) can be installed in a remote location and connection through simple wires to the REPO connector.
- ◆ The remote switch can be connected to several UPS's in a parallel architecture allowing the user to stop all units at once.